

INSTALLATION INSTRUCTIONS

MODEL: KIT10402

READ THIS FIRST

KEEP THIS INSTRUCTIONS

Please read this instruction carefully. Luminaires must be installed in accordance with the National Electrical Code (NEC) and local codes. Failure to do so will void the warranty and may result in serious injury and/or damage to the luminaire.

SAFETY WARNING: Luminaire can become very hot depending on lamp wattage used. Lens and metal around lamp can become hot enough to blister hands. Particular care should be taken not to locate luminaires where small children can reach them if high wattage lamps are used.

NOTE: LUMINAIRES ARE NOT TO BE INSTALLED WITHIN 10 FT. (3.05M) OF A POOL OR SPA. SECONDARY CABLE IS NOT TO BE BURIED MORE THAN 6". WHEN USING MULTIPLE LUMINAIRES, LOAD IS NOT TO EXCEED THE TOTAL WATTS OF TRANSFORMER RATING. DO NOT USE EXTENSION CORDS ON POWER UNITS.
NOTE: Always use UL recognized wire connectors for connections. LUMINAIRE IS FOR ABOVE GROUND INSTALLATION ONLY.

LAMP INSTALLATION/REPLACEMENT:

CAUTION: Do not exceed maximum wattage marked on luminaire label.

1. To prevent electrical shock, disconnect transformer from electrical supply before service.
2. Screw the Hood from the bottom body.
3. Replace lamp with correct wattage and type marked on fixture label.
4. Re-install the Hood.

NOTE: Avoid aiming fixture directly upward. Whenever possible, set at angle to prevent rain or irrigation water from settling on lens.

ASSEMBLY AND INSTALLATION

1. Determine desired location for mounting Luminaires.
2. At desired location, hammer the spike into ground. To avoid damage to spike, place a board on the top of the spike while hammering. If ground is hard and spike is difficult to install, make a crosscut in ground using a flat shovel.
3. Clear away area in ground at wireway slot in top of spike.
4. Lay 12V cable into wireway slot and screw luminaire in to spike. Aim luminaire in desired direction.
5. Loosen the Hood screw and Pull the Hood out. Screw the top body and Install the MR16 lamp into the socket. And then install the top body and Hood. Loosen the thumb screws to get desired angle, then tightening the thumb screw.
6. TURN OFF POWER.
7. Make wire connections using approved wiring connection method (not supplied).

FIXTURE DETAILS:

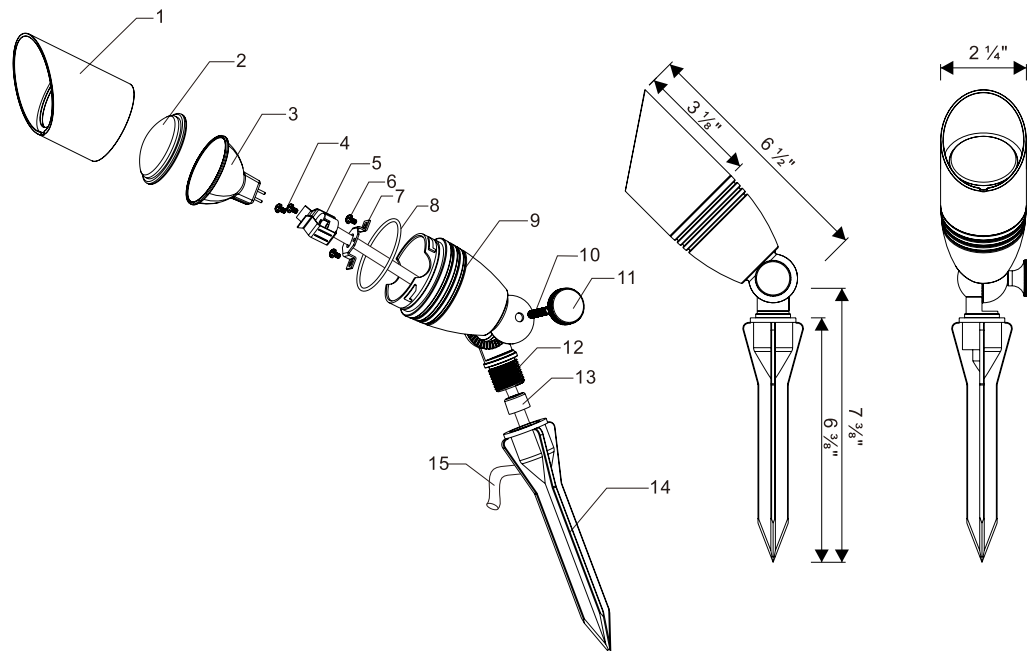

- 1.Hood 2.Convex Lens 3.MR16 Lamp (not included) 4.Socket Screw 5.Socket
6. Bracket Screw 7.Bracket 8.O Ring 9.Bottom Body 10.Screw Rod 11.Thumb screw
12.Knuckle 13.Rubber Plug 14.Spike 15.SPT1W-18 WIRE

ASSEMBLY AND INSTALLATION

1. Determine desired location for mounting Luminaires.
2. At desired location, hammer the spike into ground. To avoid damage to spike, place a board on the top of the spike while hammering. If ground is hard and spike is difficult to install, make a crosscut in ground using a flat shovel.
3. Clear away area in ground at wireway slot in top of spike.
4. Lay 12V cable into wireway slot and screw luminaire in to spike. Aim luminaire in desired direction.
5. Expose the socket by loosening the shade connector from stem. Install the G4 lamp into the socket. Re-install shade connector back to stem.
6. TURN OFF POWER.
7. Make wire connections using approved wiring connection method (not supplied).

FIXTURE DETAILS:

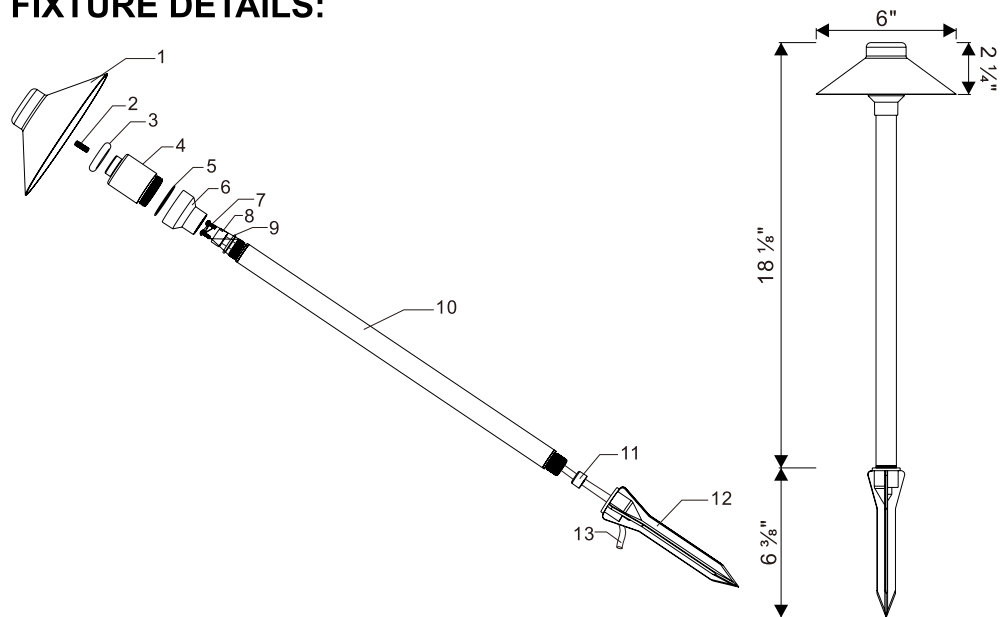

1. Shade
2. Shade Screw
3. Gasket
4. Lens
5. Gasket
6. Cone
7. Socket Screw
8. Socket
9. O Ring
10. Stem
11. Rubber Plug
12. Spike
13. SPT1W-18 Wire

LAMP INSTALLATION/REPLACEMENT:

CAUTION: Do not exceed maximum wattage marked on luminaire label.

1. To prevent electrical shock, disconnect transformer from electrical supply before service.
2. Unscrew the shade connector to expose the socket.
3. Replace lamp with correct wattage and type marked on fixture label.
4. Re-install the shade connector back to the Cone.

NOTE: DO NOT touch lamp with bare hands. Always use soft cloth or the plastic wrapping (if available) from lamp to handle the lamp. Halogen lamps must be protected from moisture and dust at all times.

IMPORTANT SAFETY INSTRUCTIONS THE LIGHTED LAMP IS HOT!!

WARNING: TO REDUCE THE RISK OF FIRE,
OR INJURY TO PERSONS:

1. Turn off/unplug and allow to cool before replacing lamp.
2. Lamps get hot quickly! Contact only switch/plug when turning on.
3. Do not touch hot lens, guard or enclosure.
4. Keep lamp away from material that may burn.
5. Do not touch the lamp at any time. Use a soft cloth. Oil from the skin may damage lamp.
6. Do not operate luminaire fitting with a missing or damaged cover.